

DESCRIPTION

- ELECTRONIC BALLAST
- ELECTRONIC TRANSFORMER
- SWITCH MODE POWER SUPPLY

FEATURES:

- LOW THERMAL RESISTANCE
- HIGH INPUT RESISTANCE
- FAST SWITCHING
- ROHS COMPLIANT

MAXIMUM RATINGS (T_c=25°C)

PARAMETER	SYMBOL	VALUE	UNIT
Drain-source Voltage	VDS	900	V
gate-source Voltage	VGS	±30	V
Continuous Drain Current (T _C =25°C)	ID	4	A
Drain Current-Pulsed	IDM	12	A
Total Dissipation	PD	35	W
Junction Temperature	T _j	150	°C
Storage Temperature	T _{stg}	-55-150	°C
Single Pulse Avalanche Energy (I _{AS} =4A)	EAS	50	mJ

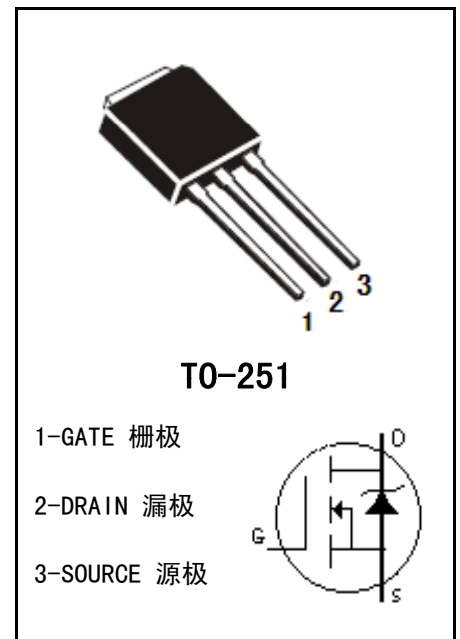
MECHANICAL

ELECTRONIC CHARACTERISTICS (T_c=25°C)

CHARACTERISTICS	SYMBOL	TEST CONDITION	MIN	MAX	UNIT
Drain-source Breakdown Voltage	BVDSS	VGS=0V, ID=250 μ A	900		V
Gate Threshold Voltage	VGS (TH)	VGS=VDS, ID=250 μ A	2.5	4.5	V
Drain-source Leakage Current	IDSS	VDS=900V, VGS=0V		1	uA
Drain-Source Diode Forward Voltage	VSD	VGS=0V, IS=2A		1.5	V
Gate-body Leakage Current (VDS = 0)	IGSS	VGS=±30V		±100	nA
Static Drain-source On Resistance	RDS (ON)	VGS=10V, ID=2A		1.5	Ω
Thermal Resistance Junction-case	RthJ-c			3.5	°C/W

■ DYNAMIC CHARACTERISTICS (T_c=25°C)

CHARACTERISTICS	SYMBOL	TEST CONDITION	MIN	TYP	MAX	UNIT
Input Capacitance	C _{iss}	V _{DS} =25V, V _{GS} =0V, f=1.0MHz	-	320	-	pF
output Capacitance	C _{oss}		-	75	-	pF
Reverse Transfer Capacitance	C _{rss}		-	5	-	pF

■ SWITCHING CHARACTERISTICS (T_c=25°C)

CHARACTERISTICS	SYMBOL	TEST CONDITION	MIN	TYP	MAX	UNIT
Turn-On Delay Time	t _{d(on)}	V _{DD} =400V, I _D =2A, R _G =20Ω, V _{GS} =10V	-	10	-	ns
Turn-On Rise Time	t _r		-	8	-	ns
Turn-Off Delay Time	t _{d(off)}		-	60	-	ns
Turn-Off Rise Time	t _f		-	13	-	ns
Total Gate Charge	Q _g	V _{DS} =480V, I _D =2A, V _{GS} =10V	-	15	-	nC
Gate-Source Charge	Q _{gs}		-	3	-	nC
Gate-Drain Charge	Q _{gd}		-	6	-	nC

■ DRAIN-SOURCE DIODE MAXIMUM RATINGS AND CHARACTERISTICS (T_c=25°C)

CHARACTERISTICS	SYMBOL	TEST CONDITION	MIN	TYP	MAX	UNIT
Max. Diode Forward Current	I _S		-	-	4	A
Max. Pulsed Forward Current	I _{SM}		-	-	12	A
Diode Forward Voltage	V _{SD}	V _{GS} =0V, I _S =2A	-	-	1.5	V
Reverse Recovery Time	t _{rr}	V _{GS} =0V, I _S =2A, dI _F /dt=100A/μs,	-	180	-	ns
Reverse Recovery Charge	Q _{rr}		-	1.5	-	μC



CHARACTERISTICS CURVE

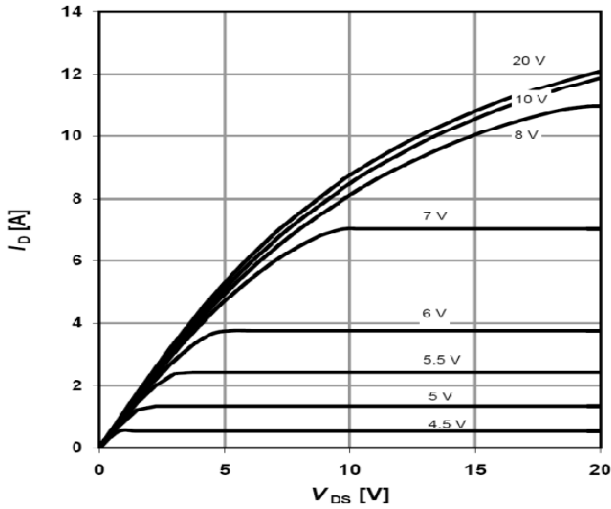

Output Characteristic

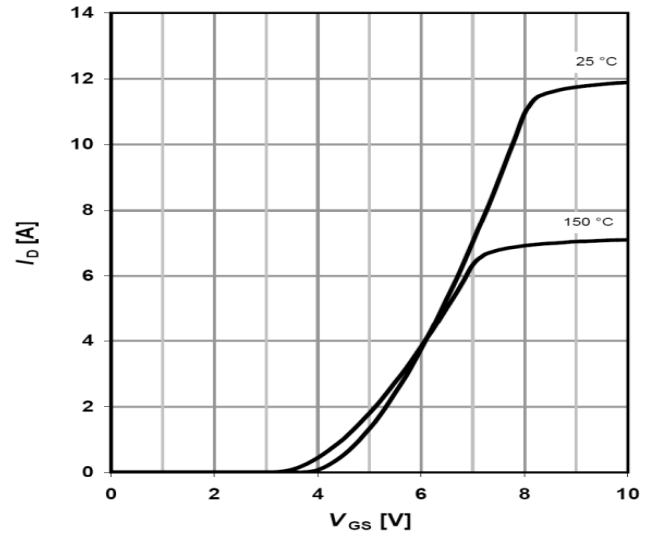

Transfer Characteristic

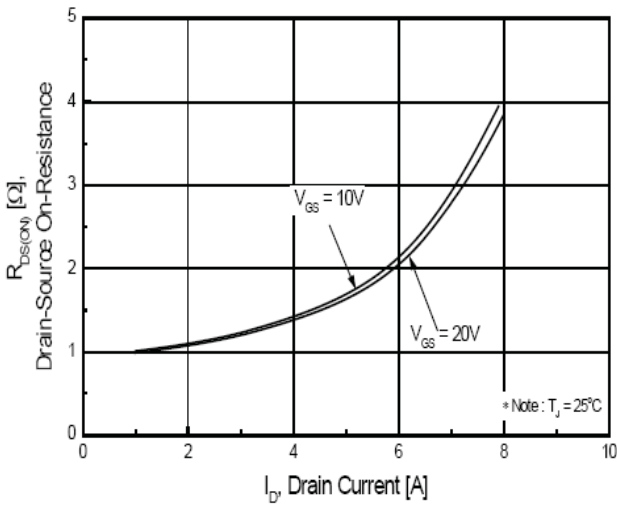

On Resistance Vs Drain Current

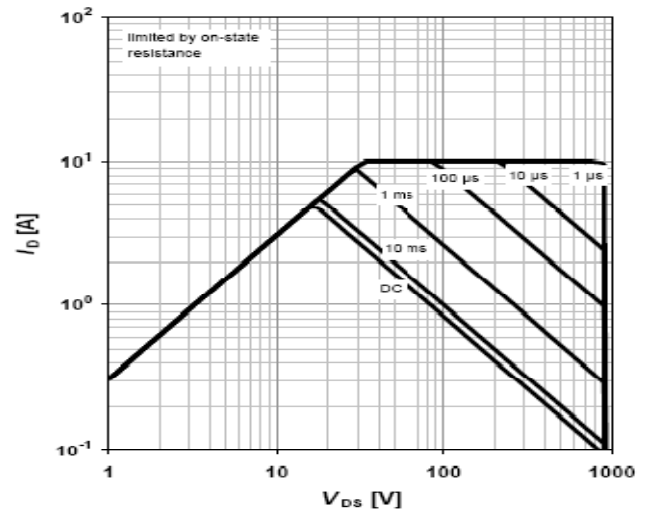

Safe Operating Area

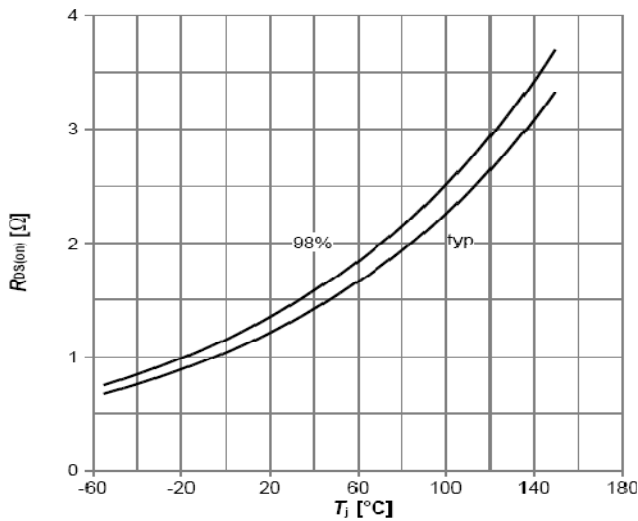

On Resistance Vs Junction Temperature

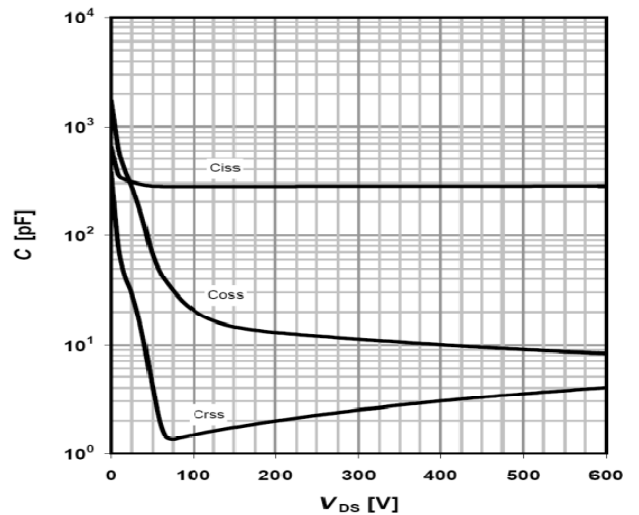

Capacitance

■ CHARACTERISTICS CURVE

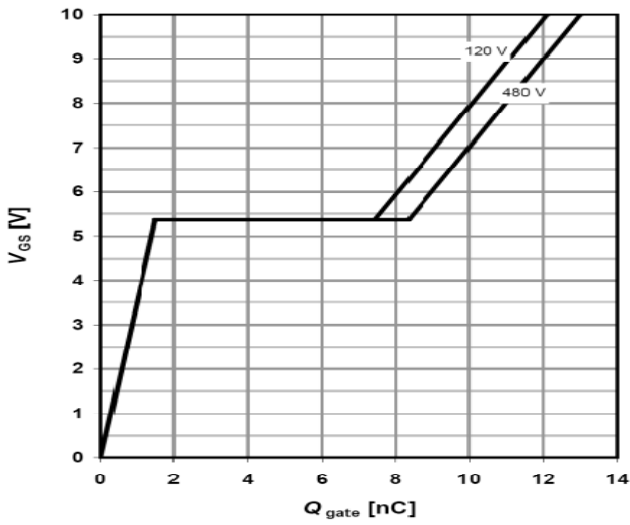

Gate Charge Waveform

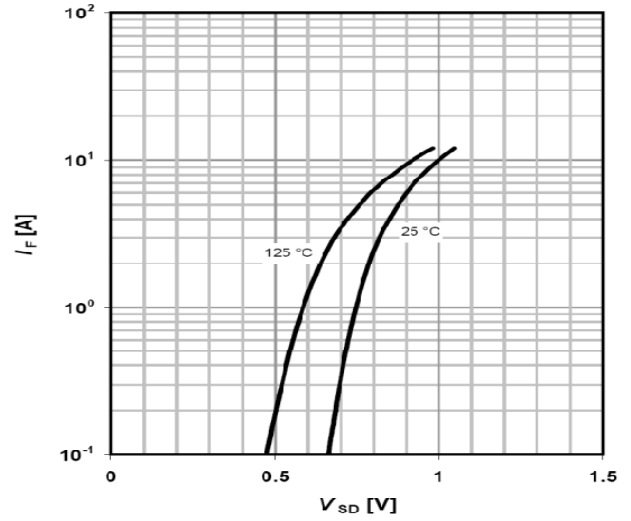

Source-Drain Diode Forward Voltage

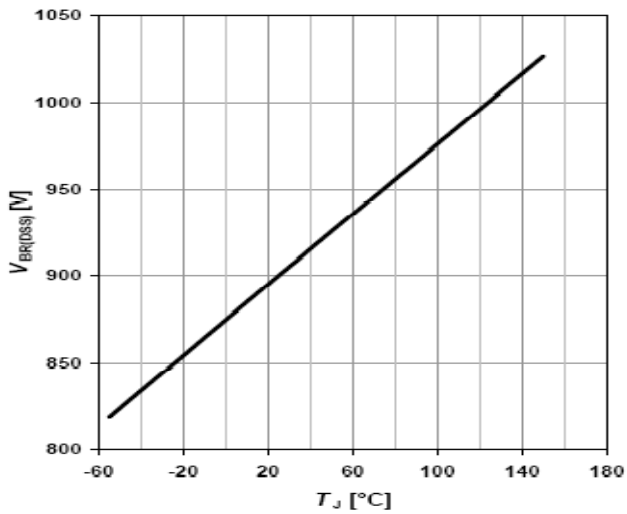

Breakdown Voltage Vs Junction Temperature



TO-251 MECHANICAL DATA

UNIT: mm

SYMBOL	MIN	NOM	MAX	SYMBOL	MIN	NOM	MAX
A	2.10		2.50	D1	5.10		5.50
A1	0.95		1.30	E	5.80		6.30
B	0.80		1.25	e	2.25	2.30	2.35
b	0.50		0.80	L	7.70		8.50
b1	0.70		0.90	L1	1.45		1.95
C	0.45		0.60	R		0.30	
C1	0.45		0.60				
D	6.35		6.75				

